

2200 Series / 2600 Series – General Purpose Industrial Pressure Transducers

- ▶ Gauge, Absolute, Vacuum and Compound Pressure Models Available
- ▶ Submersible, General Purpose and Wash Down Enclosures
- ▶ High Stability Achieved by CVD Sensing Element
- ▶ Millivolt, Voltage and Current Output Models

The 2200 series features stability and accuracy in a variety of enclosure options. The 2600 series extends the packaging options via an all welded stainless steel back end for demanding submersible and industrial applications. The 2200 and the 2600 feature proven CVD sensing technology, an ASIC (amplified units), and modular packaging to provide a sensor line that can easily accommodate specials while not sacrificing high performance.

Specifications

Input	
Pressure Range	Vacuum to 6000 psi (400 bar)
Proof Pressure	2 x Full Scale (FS) (1.5 x Fs for 400 bar, ≥ 5000 psi)
Burst Pressure	>35 x FS <= 100 psi (6 bar); >20 x FS >= 1000 psi (60 bar); >5 x FS <= 6000 psi (400 bar)
Fatigue Life	Designed for more than 100 million FS cycles
Performance	
Long Term Drift	0.2% FS/year (non-cumulative)
Accuracy	0.25 % FS typical (optional 0.15% FS)
Thermal Error	1.5% FS typical (optional 1% FS)
Compensated Temperatures	-5°F to +180°F (-20°C to +80°C)
Operating Temperatures	-40°F to +260°F (-40°C to +125°C) for elec. codes A, B, C, 1 -5°F to +180°F (-20°C to +80°C) for elec. codes 2, D, G, 3 -5°F to +125°F (-20°C to +50°C) for elec. codes F,M, P Amplified units >100°C maximum 24 VDC supply
Zero Tolerance	1% of span
Span Tolerance	1% of span
Response Time	0.5 ms
Mechanical Configuration	
Pressure Port	See ordering chart
Wetted Parts	17-4 PH Stainless Steel
Electrical Connection	See ordering chart
Enclosure	316 ss, 17-4 PH ss IP65 NEMA 4 for elec. codes A, B, C, D, G, 1, 2, 3 IP67 for elec. code "F" IP68 for elec. codes M, (max depth 200 meters H ₂ O) IP30 for elec. code "3" with flying leads
Vibration	70g, peak to peak sinusoidal, 5 to 2000 Hz (Random Vibration: 20 to 2000 Hz @ ≈20g Peak per MIL-STD.-810E Method 514.4)
Acceleration	100g steady acceleration in any direction 0.032% FS/g for 15 psi (1 bar) range decreasing logarithmically to 0.0007% FS/g for 6000 psi (400 bar) range.
Shock	20g, 11 ms, per MIL-STD.-810E Method 516.4 Procedure I
Approvals	CE, UR (221C, 261C, 22CS, 26CS)
Weight	Approx. 100 grams (additional cable; 75 g/m)

Series 2200



Series 2600



PRESSURE TRANSDUCERS

Individual Specifications

Millivolt Output units	
Output	100 mV (10 mv/v)
Supply Voltage (Vs)	10 VDC (15 VDC max.) Regulated
Bridge resistance	2600-6000 ohms
Voltage Output units	
Output	see ordering chart
Supply Voltage (Vs)	1.5 VDC above span to 35 VDC @ 6 mA
Supply Voltage Sensitivity	0.01% FS/Volt
Min. Load Resistance	(FS output / 2) Kohms
Current Consumption	approx 6 mA at 7.5V output
Current Output units	
Output	4-20 mA (2 wire)
Supply Voltage (Vs)	24 VDC, (7-35 VDC)
Supply Voltage Sensitivity	0.01% FS/Volt
Max. Loop Resistance	(Vs-7) x 50 ohms

Electromagnetic Capability

Meets the requirement for CE marking of EN50081-2 for emissions and EN50082-2 for susceptibility.

Test Data:

- EN61000-4-2 Electrostatic Discharge. 8kV air discharge, 4kV contact discharge. Unit survived.
- ENV50140 Radiated RF Susceptibility. 10V/m, 80MHz-1GHz, 1kHz mod. Maximum recorded output error was $<\pm 1\%$
- ENV50204 Radiated RF Susceptibility to Mobile Telephones. 10V/m, 900MHz. Maximum recorded output error was $<\pm 1\%$.
- EN61000-4-4 Fast Burst Transient. 2kV, 5/50ns, 5kHz for 1 minute. Unit survived.
- ENV50141 Conducted RF Susceptibility. 10Vms, 1kHz mod, 150kHz - 80MHz. Maximum recorded output error was $<\pm 1\%$

Connection Code		mV units				Voltage units				Current units (4-20mA)		
		IN+	OUT+	OUT-	IN-	IN+	COM	OUT+	EARTH	(+)	(-)	EARTH
A, B, G	"DIN" PIN	1	2	3	E	1	2	3	4	1	2	4
C	"10-6 Bayonet" PIN	A	B	C	D	A	C	B	E	A	B	E
D	"cable"	R	Y	BL	G	R	BK	W	DRAIN	R	BK	DRAIN
F	"IP 67 cable"	R	Y	BL	G	R	BK	W	DRAIN	R	BK	DRAIN
M	"Immersible"	R	Y	BL	W	R	W	Y	DRAIN	R	BL	DRAIN
1	"8-4 Bayonet" PIN	A	B	C	D	A	C	B	D	A	B	D
2	"cable"	R	W	G	BK	R	BK	W	DRAIN	R	BK	DRAIN
3	"conduit & cable"	R	W	G	BK	R	BK	W	DRAIN	R	BK	DRAIN

Cable Legend:

R = Red
BL = Blue
BK = Black
W = White
Y = Yellow

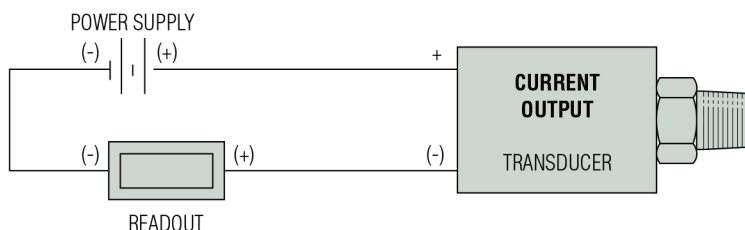
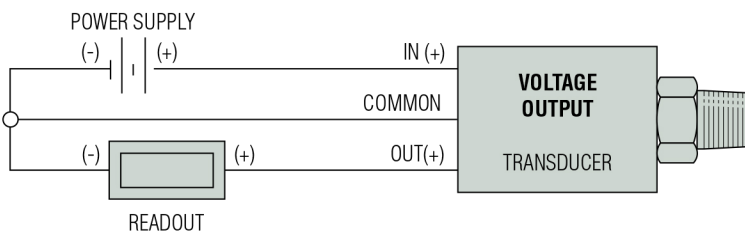
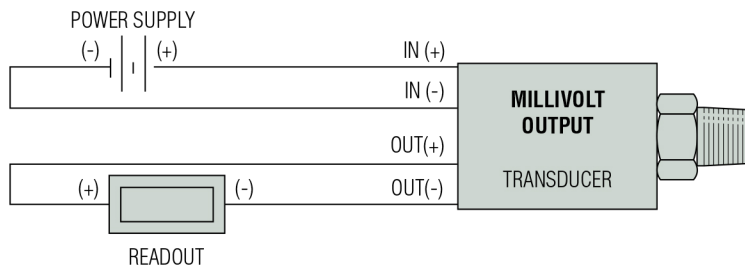



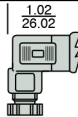
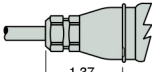
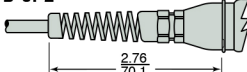

Dimensions

2200 Series

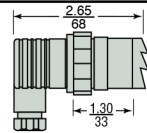
Mini 4 Pin - No Connector
Code B 
Mini 4 Pin - With Connector
Code A  1.02 26.02
IP67 Cable (Waterproof)
Code F  1.37 35.0 24 AWG Shielded PVC
IP65 or NEMA4 Cable
Code D or 2  2.76 70.1 24 AWG Shielded PVC

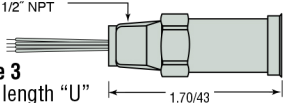
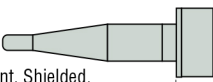
2600 Series







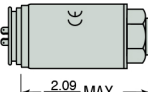
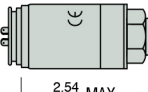

10-6 or 8-4 Mil-C Connector
10-6 Code C  8-4 Code 1 0.87 22
Large DIN 43650 Plug
Code G  2.65 68 1.30 33
Conduit Connector with Cable
Code 3 1/2" NPT  24 AWG Shielded PVC 43 1.70
Conduit Connector with Flying Leads
1/2" NPT  Code 3 with length "U" 1.70/43
Moulded, Immersible Cable
Code M  24 AWG, Vent, Shielded, Polyurethane 0.90 23

mV Gauge/Absolute Amplified Gauge  2.43 61.60 MAX
Amplified Absolute  2.48 65.7 MAX

Maximum diameter 1.07" (27.3 mm)

mV Gauge/Absolute Amplified Gauge  2.09 53.2 MAX
Amplified Absolute  2.54 64.4 MAX

Maximum diameter 1.07" (27.3 mm)

1/8-27 NPT
Code 08  0.59 15
1/4 - 18 NPT
Code 02 with snubber Code 0J with snubber  0.79 20
1/4-18 NPT Internal
Code 0E  0.95 24
1/2-14 NPT
Code 0H  1.02 26.0
7/16-20 UNF-2A
Code 04  0.75 19
9/16-18 UNF-2A
Code 1P  0.67 17
G 1/8 Internal
Code 09 
G 1/4 External
Code 01  0.67 17
R 1/4
Code 0A  0.79 20

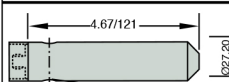
Nose Cone - Black Acetal
Code 19  0.75 19
Nose Cone Sink Weight
 4.67/121 0.27/20 Through hole Ø 10.0
Code 29

inch
mm

How to Order

Use the **bold** characters from the chart below to construct a product code

2200 B G A60 01 A 3 U A

Series —————→ **2200 2600**

Output —————→ **A - 100 mV C - 1-6V J - 0.5-5.5V G - 0.2-10.2V**
B - 4-20mA D - 1-11V R - 0-5V F - 0.1-5.1V
H - 1-5V S - 0-10V

Pressure Datum —————→ **A* - Absolute G - Gauge**
 *Max absolute range is 25 bar. (≤ 300 psi)

Pressure Range³ – psi —————→ **G60 - 0-600 Vac = -15 psi**
F07 - 0-7.5 H10 - 0-1,000 1F5 - Vac-0
F15 - 0-15 H15 - 0-1,500 3F0 - Vac-15
F30 - 0-30 H20 - 0-2,000 6F0 - Vac-45
F60 - 0-60 H30 - 0-3,000 1G0 - Vac-85
G10 - 0-100 H40 - 0-4,000 1G5 - Vac-135
G15 - 0-150 H50 - 0-5,000 2G0 - Vac-185
G20 - 0-200 H60 - 0-6,000 3G0 - Vac-285
G30 - 0-300
G50 - 0-500

Pressure Range - bar —————→ **B25 - 0-25 Vac = -1 bar**
A10 - 0-1 B40 - 0-40 1A0 - Vac-0
A16 - 0-1.6 B60 - 0-60 1A6 - Vac-0.6
A25 - 0-2.5 C10 - 0-100 2A5 - Vac-1.5
A40 - 0-4 C16 - 0-160 4A0 - Vac-3
A60 - 0-6 C25 - 0-250 6A0 - Vac-5
B10 - 0-10 C40 - 0-400 1B0 - Vac-9
B16 - 0-16 1B6 - Vac-15
2B5 - Vac-24
4B0 - Vac-39

Pressure Port —————→ **08 - 1/8-27 NPT External European Threads**
02 - 1/4-18 NPT External 09 - G1/8 Internal
0J - 1/4 NPT External w/snubber 01 - G1/4 External
0E - 1/4 NPT Internal 0A - R1/4 External
0H - 1/2-14 NPT External Submersible (2600 only)
04 - 7/16-20 External (SAE #4, J514) 19 - Plastic Nose Cone
1P - 9/16-18 External (SAE #6, J1926-2) 29 - Sink Weight Nose Cone
1J - 7/16-20 External (SAE #4, J1926-2)

Performance Code
 Accuracy/Thermal
A - .25%/1.5%
B - .15%/1.0%

Cable Length¹
U - No Cable Fitted^{1 2}
D - 1 Metre (3 feet)
E - 3 Metres (9 feet)
F - 5 Metres (16 feet)
G - 10 Metres (32 feet)

Apparatus Protection
2 - mV Only Transient Protection CE Mark, UR
3 - Amplified Only RFI Protected CE Mark, UR

Electrical Connection (See Notes)
 2200 Series
A - 4 PIN DIN (Micro) Mating Connector Supplied
B - 4 PIN DIN (Micro) Mating Connector Not Supplied
2 - Cable Nema 4 USA
D - Cable European Color Code
F - Cable Gland Metal IP67

2600 Series
C - Fixed Plug Size 10-6 Mating Plug Not Supplied
G - Fixed Plug To DIN 43650 Mating Plug Supplied
M - Moulded Cable Immersible
1 - Fixed Plug Size 8-4 Mating Plug Not Supplied
3 - Conduit Connector 1/2NPT Ext. 1M Cable²

Notes:
 1. When electrical connection is cable please select a cable length from Table 1 below. When electrical connection is DIN or plug style "U" must be specified.
 2. Where electrical connection -**3** and cable length -**U** occur in part number, the unit will be supplied with flying leads (4-1/2" IP30).
 3. Additional Pressure Ranges are available. Please consult factory.

Table 1 - Cable Length

(2600 Series) (2200 Series select "U" through "G")

Code	Length (M)	Code	Length (M)
U	No Cable Fitted	M	40
D	1	N	50
E	3	P	75
F	5	Q	100
G	10	R	125
H	15	S	150
J	20	4	170
K	25	5	200
L	30	6	225

Note: Maximum cable length on a 2200 is 10 meters.

